

Table of Contents:

▪ System Overview.....	2	▪ Pre-Planning.....	5
▪ Clips and Accessories.....	3	▪ Calculating Basic Grid Quantities.....	5
▪ Grid Components and Slot Positions.....	4	▪ Suspension System Installation.....	6-11

Chicago Metallic® Drywall Grid

Interior Installation Guide for Standard Drywall Grid Systems



System Overview

This guide covers the basic installation guidelines for Chicago Metallic standard drywall grid systems. The basic framework includes knurled main runners, cross tees, and utility angle. Installed properly, the suspension system supports single layer and double layer drywall applications.

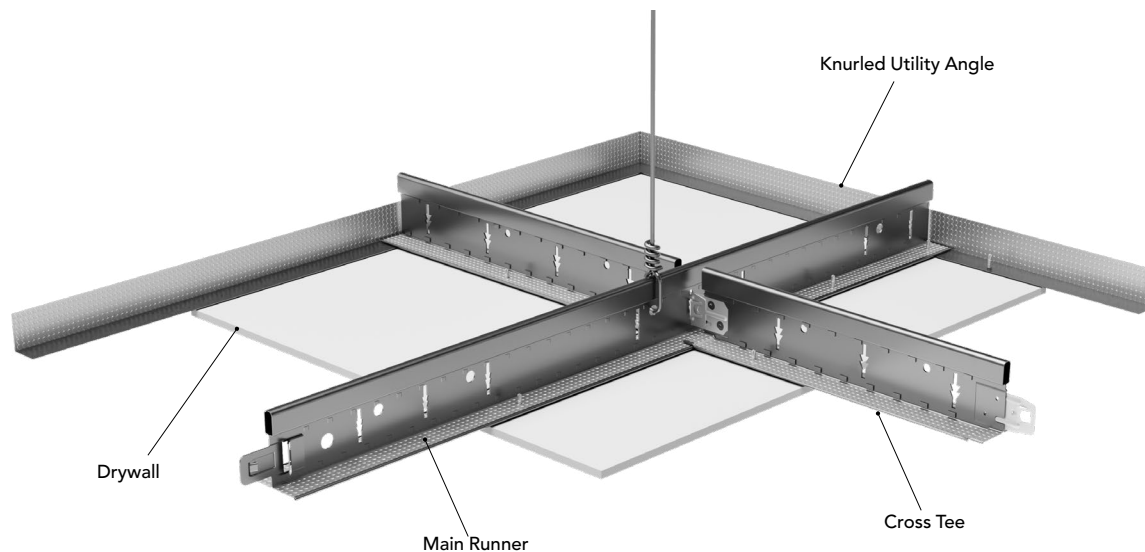

Best Practices

Always follow good safety practices when installing ceilings. Prior to beginning installation ensure that all materials are received and in good condition. Record any shipping damage on the carrier's bill of lading and contact Rockfon immediately to order replacement material:

- Email: cs@rockfon.com
- Fax: 866.211.3824

If there are any issues with your order, contact Customer Service at 1-800-323-7164, telephone option 1. E-mail replacement material orders, including your purchase order number on document, to cs@rockfon.com. For technical assistance, contact Technical Services at 1-800-323-7164, telephone option 2.

Reference Documentation

Several industry standards are published and available. Acoustical and metal ceiling installers should familiarize themselves with the installation methods and best practices recommended for ceiling systems.

Prior to installation, it's imperative the installer become familiar with any project specific documentation available. These items will confirm ceiling layout, panel sizes and finish, ceiling accessories, ceiling fixture layout and orientation, and any special edge conditions.

Industry Standard Documentation

- [ASTM C636 \(Standard Practice for Installation of Metal Ceiling Suspension Systems for Acoustical Tile and Lay-In Panels\)](#)
- [ASTM C754 \(Standard Specification for Installation of Steel Framing Members to Receive Screw Attached Gypsum Panel Products\)](#)
- [CISCA Ceiling Systems Handbook](#)

Project Specific Documentation

- Reflected ceiling plans
- Project specifications
- Approved project submittals (data sheets, shop drawings)







Other Documentation

- [Rockfon GRG Access Door](#)
- [Rockfon Infinity Installation Guide](#)

Tools Required

- Laser or leveling device
- Cutting knife/blades
- Marking tool (pencil)
- Pliers
- Clean gloves
- Aviation snips
- Tape measure
- Drill
- Screwdriver (Phillips, Flathead)

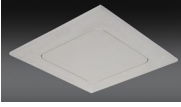
Clips and Accessories

Product	Description	Product	Description
 479.00 Clip	Use this clip when 90 degree angles are required between main runners and cross tees.	 479.090 Clip	This flat angle clip can be used for creating 90 degree soffits.
 479.030 Clip	This flat angle clip is useful for soffit framing when 30 degree angles are required.	 435.00 Clip	This clip is required when field forming drywall main runners for curved applications.
 479.045 Clip	Use this flat angle clip for soffit framing when 45 degree angles are required.	 GRG Access Doors	GRG access doors provide a seamless and monolithic appearance.
 479.060 Clip	This flat angle clip is useful for soffit framing when 60 degree angles are required.	 Drywall Track Clip	Use this clip to create transitions between acoustical and drywall ceilings.

Grid Components and Slot (Rout) Positions

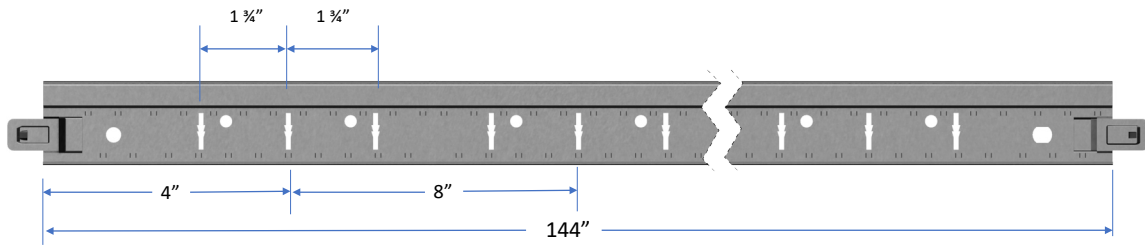

640.00D Heavy Duty Main Runner

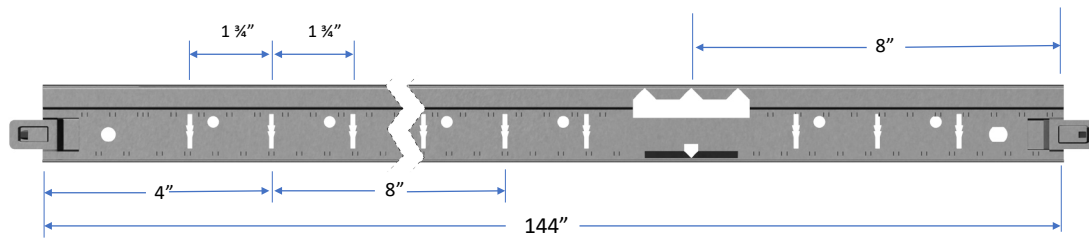

650.00D

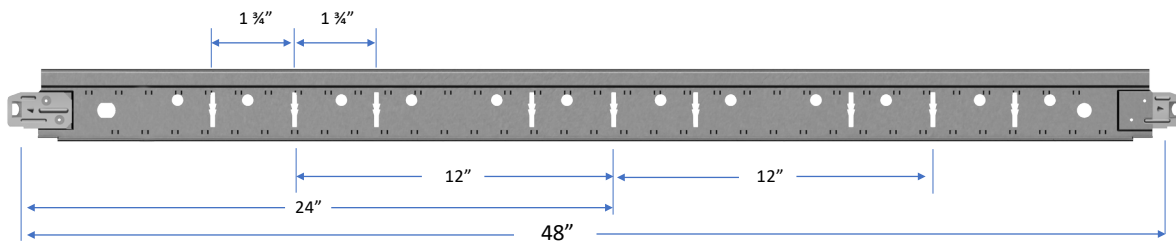

664.00D and 674.00D

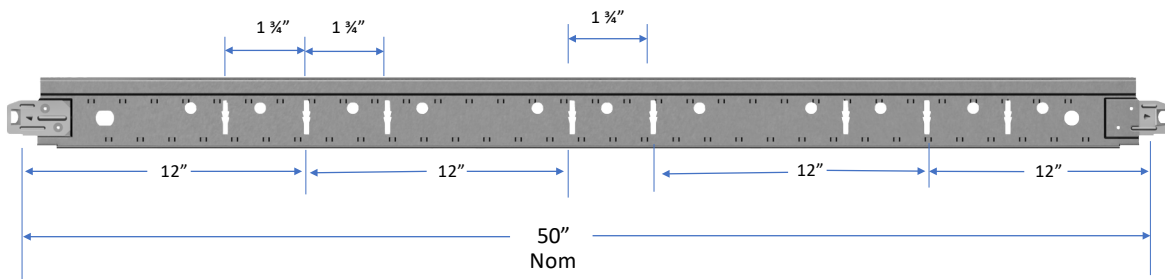

675.00D

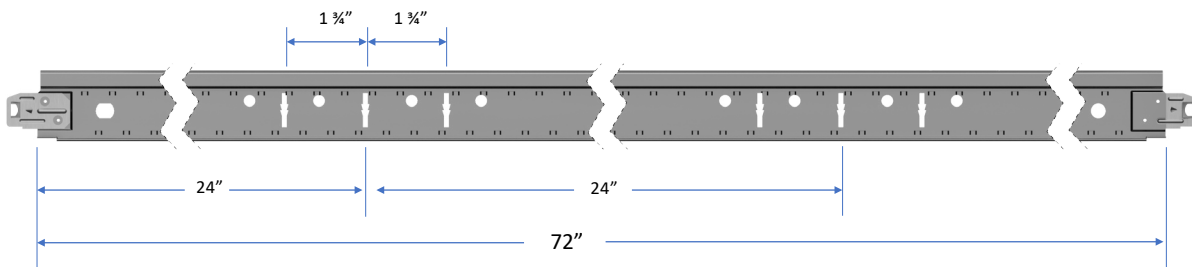

677.00D

Pre-Planning

Proper planning is essential to a good installation. The following guidelines should ensure a successful ceiling installation.

- Refer to the projects reflected ceiling plan for proposed locations of light fixtures, mechanical equipment, and access panels.
- While equal borders are not as critical as with exposed grid systems, the layout may require establishing some centerlines depending on the locations of fixtures and equipment. Most penetrations through the drywall can be adjusted to accommodate the layout, some field cutting of components and modification of the layout can be expected.

Calculating Basic Grid Quantities

If a physical count or take-off is not performed, calculating grid quantities can also be accomplished by knowing the square footage (SF) of the ceiling area and type in consideration. Once the SF is determined, the lineal footage (LF) of any grid component can be calculated once the spacing of that component is known. For example - If main runners are spaced every 4', then 4 would be divided into the SF to determine LF of main runners, and so on.

Module Size	Description	Main Runners	4' Cross Tees	6' Cross Tees
2' x 4'	MR - 4' o.c. 4' CT - 2' o.c.	(SF / 4 = LF)	(SF / 2 = LF)	N/A
2' x 6'	MR - 6' o.c. 6' CT - 2' o.c.	(SF / 6 = LF)	N/A	(SF / 2 = LF)

Membrane Loading

2 layers of drywall is generally acceptable so long as the applied weight does not exceed the allowable load of that component combination. The numbers in the table below represent allowable lbs per sf and are dependent on the hanger wire and cross tee spacing. All main runners spaced 4' o.c. For instance, a 640.00D and 664.00D combination with hanger wires spaced 48" o.c and cross tees spaced 24" o.c. will result in an allowable load of 6.5 lbs per sf.

Membrane Allowable Load Test Data (Lb/Ft²)

Component Combination Main Runner/Cross Tee	Hanger Wire/Cross Tee Spacing (L/240)		Hanger Wire/Cross Tee Spacing (L/360)	
	48"/24"	32"/16"	48"/24"	32"/16"
640.00D/664.00D	6.5	13.8	4.5	9.7
650.00D/674.00D	6.5	13.8	4.5	9.7
640.00D/677.00D	6.5	5.4	2.5	3.8
650.00D/677.00D	6.5	5.4	2.5	3.8
640.00D/675.00D	6.5	13.28	4.3	9.3
650.00D/675.00D	6.5	13.28	4.3	9.3

Membrane loading is not applicable when these components are used in a fire-rated assembly.

Consult UL Fire Resistance Directory for installation details.

650 Furring Runner values based on hanger wire installed within 3" of fire break.

Customer responsible for confirming applied load weight.

Standard Weights (approx) 1/2" drywall - 2.0 lbs. per SF

5/8" drywall - 2.5 lbs. per SF

2 layers of 5/8" drywall - 5.0 lbs. per SF

1. Suspension System Installation

All suspension should follow the guidelines of ASTM standards C636 and C754, including local building codes and standards. Special attention should be given to the squareness of the system. It is recommended that a system be square within 1/16" over an 8' diagonal. Use minimum 12-gauge galvanized steel hanger wire per ASTM C636 for suspending the grid.

1.1 Install wall angle - Secure the specified perimeter treatment (see options below) to the walls using appropriate fasteners. Reference any project documents for proper ceiling elevation and ensure perimeter treatment is installed level. Typical wall to wall installations are trimmed out by wall angle or wall channel. Floating installations are trimmed out with Infinity extruded aluminum trim, see Rockfon Infinity Installation guide for more information.

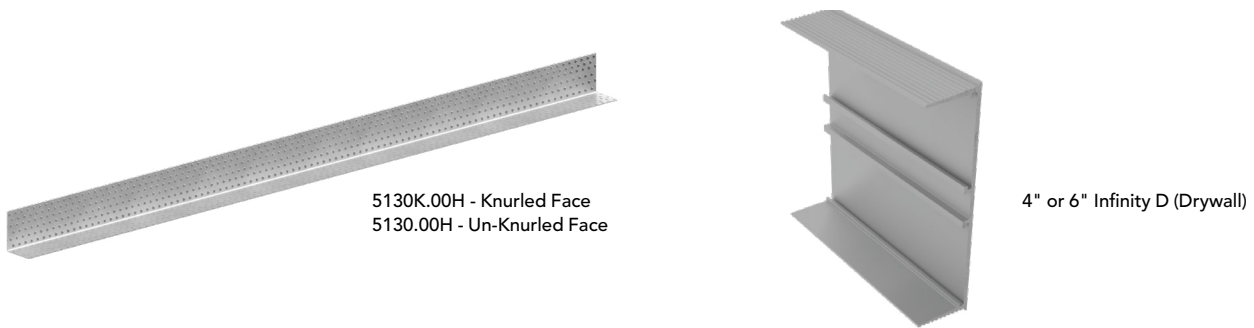

Wall Angle Installation

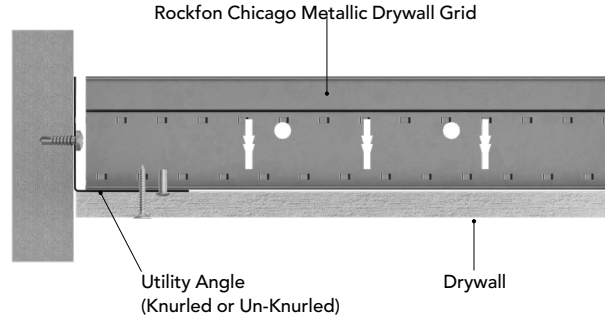

Infinity Drywall Installation

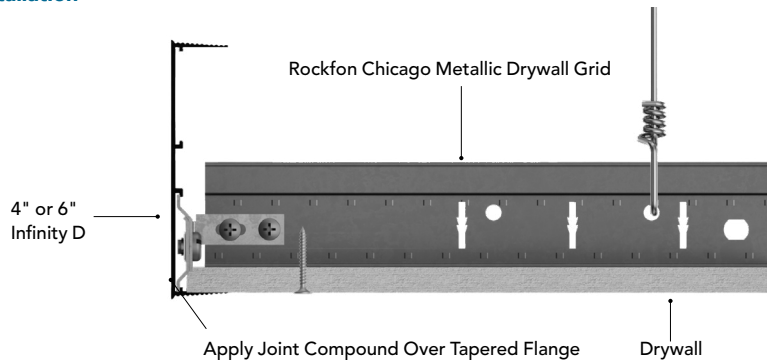

1.2 Install grid suspension - Install drywall main runners parallel to the long edge of the drywall. Suspension layouts can be installed with 4' or 6' drywall cross tees, see non-fire rated and fire rated options below.

Suspension Layout - 4' Drywall Cross Tees (Non-Fire Rated System)

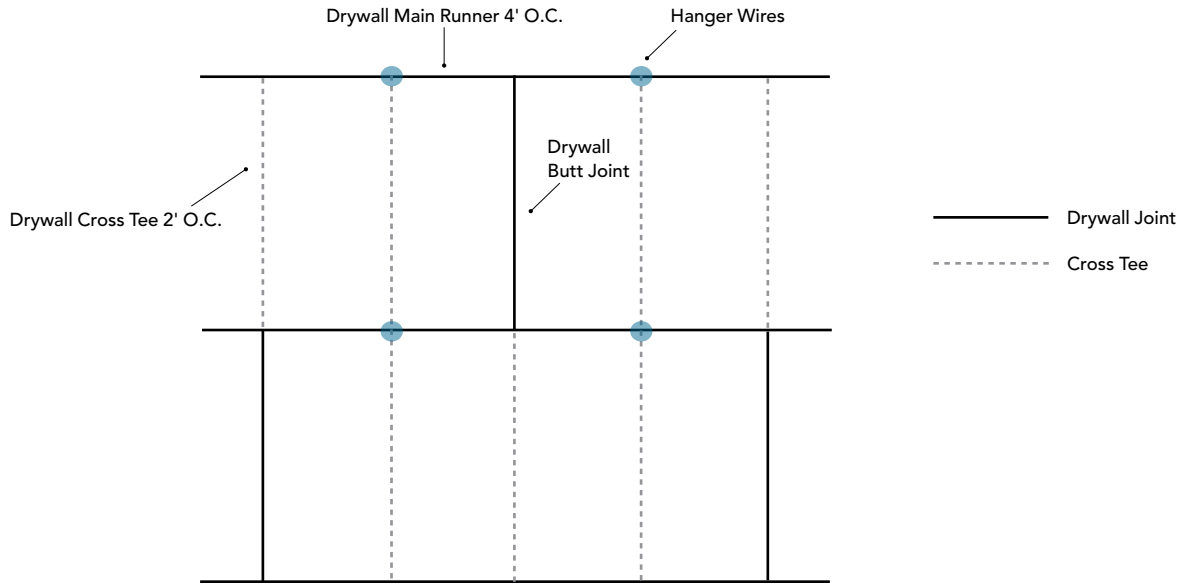

Suspension Layout - 6' Drywall Cross Tees (Non-Fire Rated System)

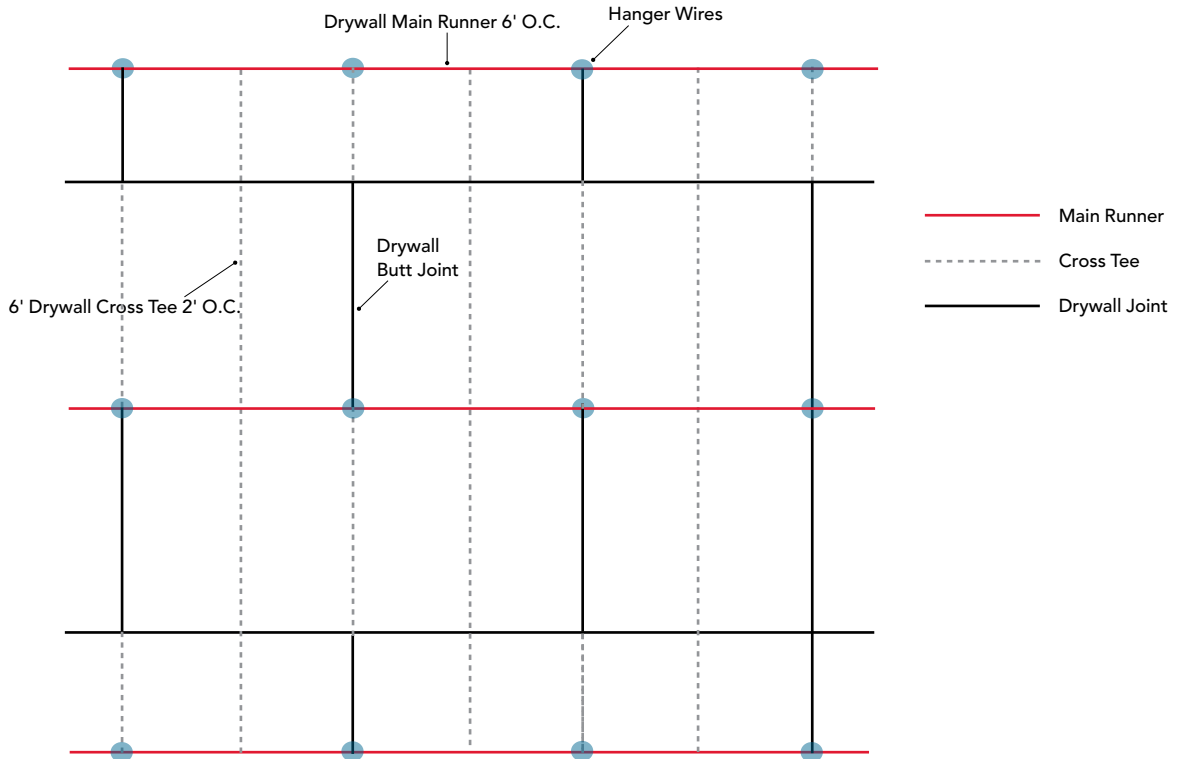

Note - Cross tees install to the right of intersecting cross tees.

Suspension Layout - 4' Drywall Cross Tees (Fire Rated System)

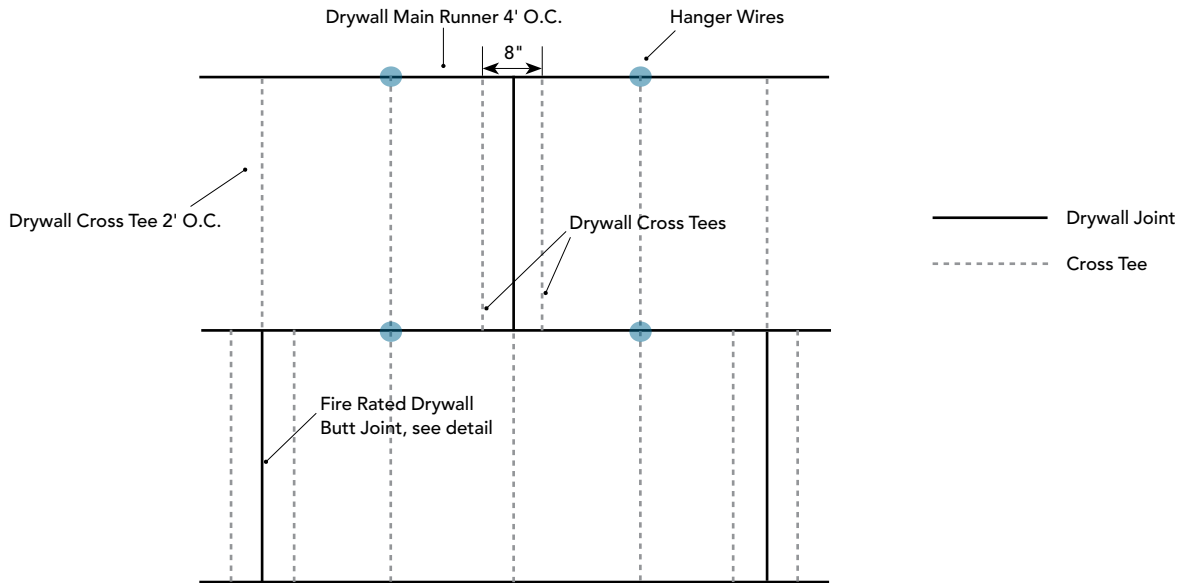

Suspension Layout - 6' Drywall Cross Tees (Fire Rated System)

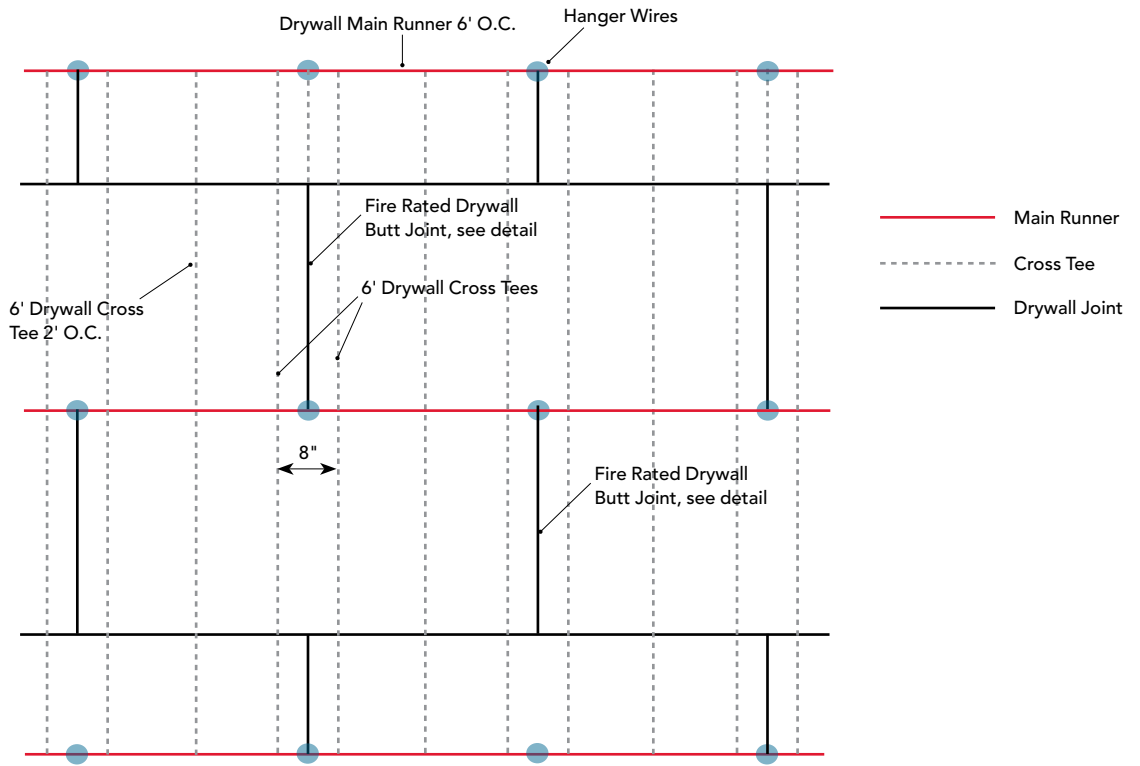

Note - Cross tees install to the right of intersecting cross tees.

Butt Joint Detail Fire Rated Installations

Top View

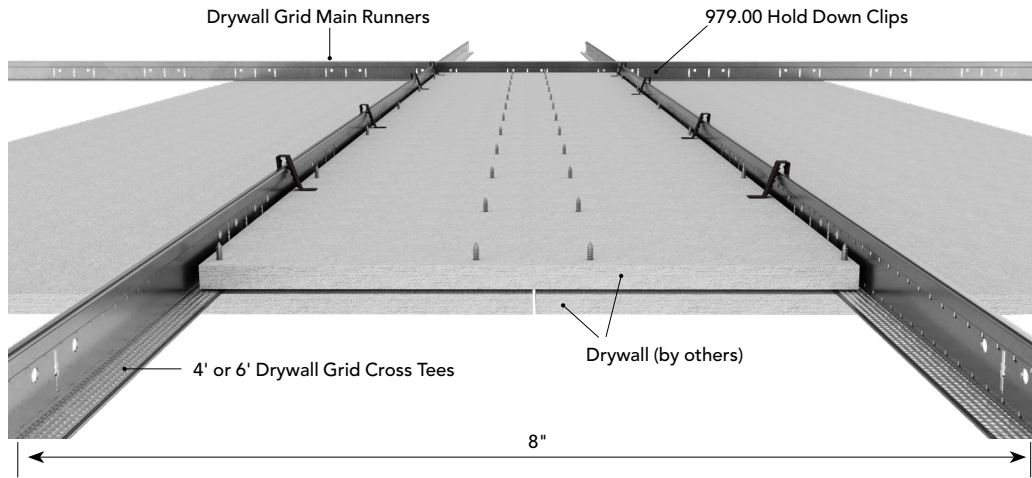

Bottom View

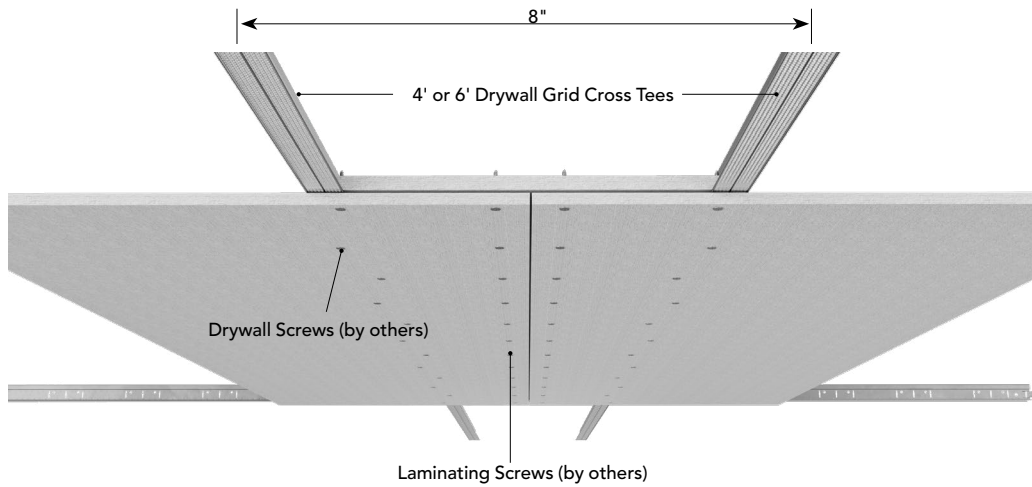

2. Drywall Soffits

Framing drywall soffits can be done a number of different ways and usually involves field cutting and notching drywall suspension. The below illustration shows how to create a 90 degree vertical return utilizing Rockfon's Chicago Metallic drywall grid, utility angle, and 90 degree flat angle clip.

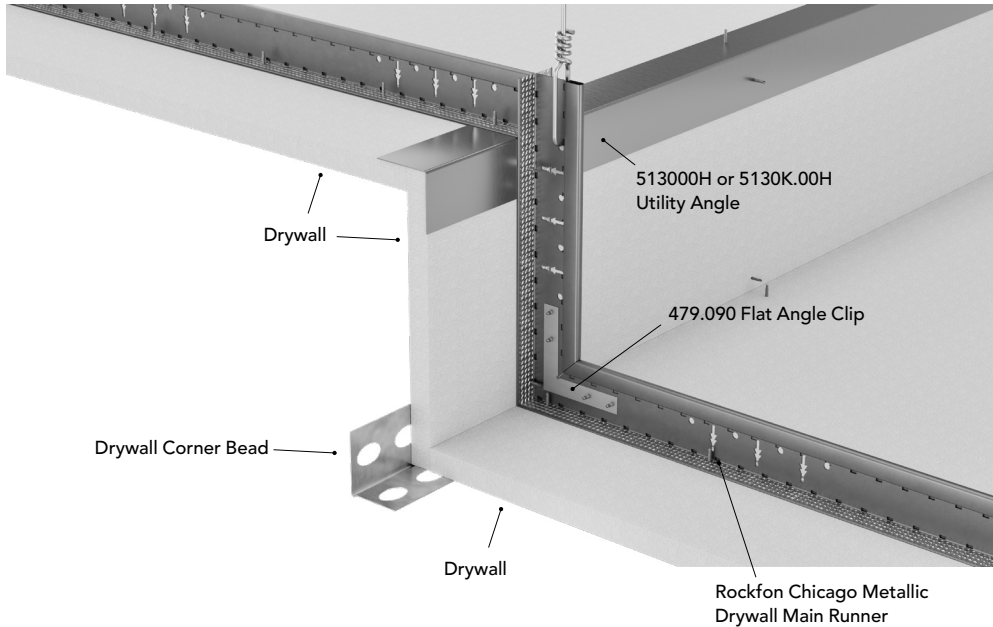

3. Curved Main Runners

First prepare an outline or template to form the drywall main runners to and field notch as required to form to this template. For smaller radius curves, decrease the spacing between notches. For larger, gradual curves, the spacing in between notches can be increased. Next, curve and stabilize the main by affixing the 435.00 clip to the bulb of the runner with #7 self drilling screws. 4' drywall cross tees can be used to space the main runners.

Note: Consult with gypsum board manufacturer to determine minimum allowable radius.

Concave Application

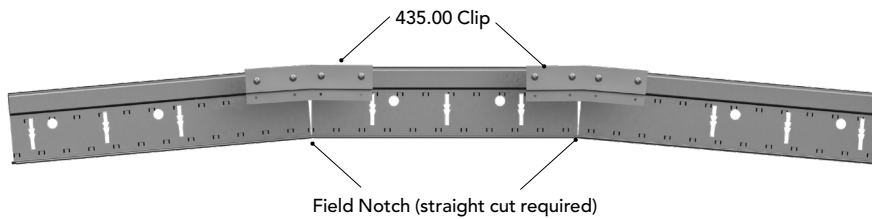

Convex Application

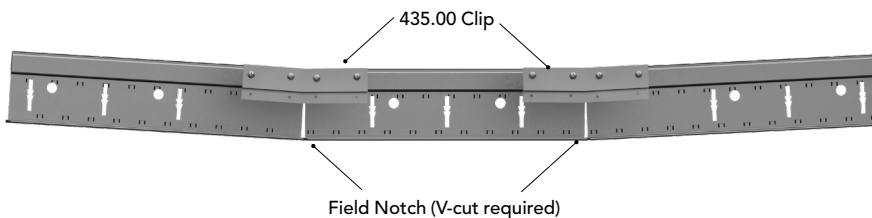

4. Type F Light Fixtures

Framing for Type F light fixtures requires actual openings of 24" and 48". This is accomplished by utilizing our 3 grouped slotting in our drywall main runners and cross tees in addition to our 50" nominal cross tee. Refer to the slot (rout) spacing above to plan your layout.

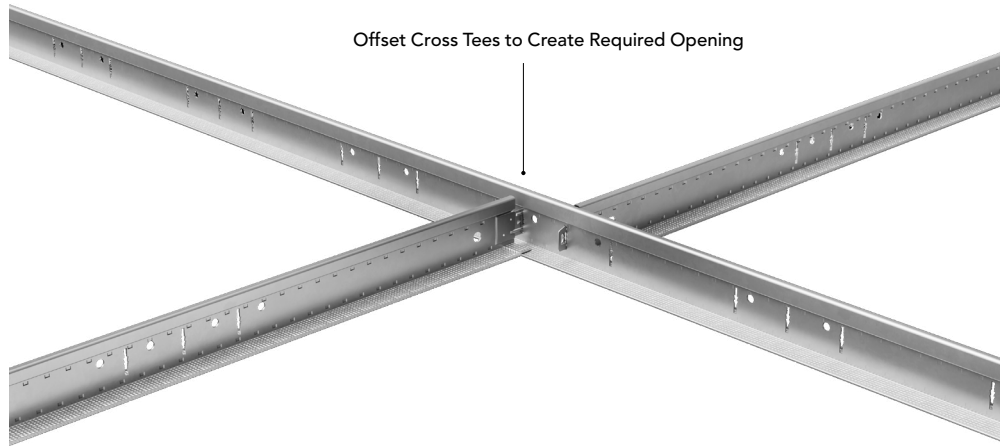

Example Layout

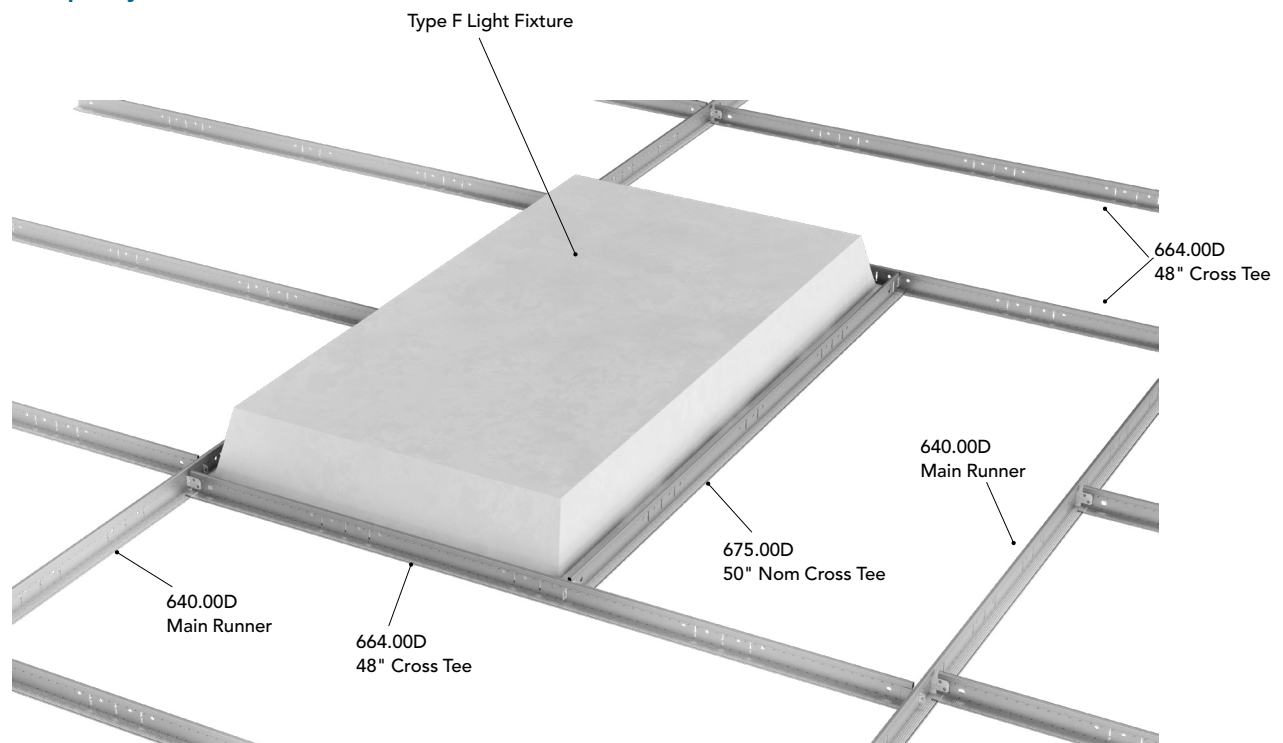

Note - Type F fixtures can also be installed perpendicular to main runners, utilize the 50" nominal cross tee (675.00D) to space the main runners.

Rockfon® is a registered trademark
of ROCKWOOL Group.

2024 | Subject to alterations in range and product technology without prior notice. Rockfon accepts no responsibility for printing errors.
® ROCKWOOL IAS 2022. All rights reserved. ® denotes a trademark that is registered in the United States of America.

062424



Rockfon
4849 S. Austin Ave.
Chicago, IL 60638 USA

Tel. +1-800-323-7164
cs@rockfon.com
rockfon.com